







The solar eclipse has inspired the design of the Eclipse lamp thanks to its two light sources direct and indirect, they can be used separately, simulating the magic of this natural phenomenon. The "cone of shadow" is made possible by the presence of a metal disc placed at the beginning of the largest aluminum dome that, hiding the light source, it generates a bright ring. Translucent Plexiglas hanging, suspended by a thin red wire, is illuminated through a narrow cone of light that draws the shapes. The light intensity can be adjustable by a dimmer. The product is equipped with multi switches to achieve different lighting scenarios.

DESCRIPTION

Suspension lamp with direct and indirect light.
Painted metal structure.
Aluminum dome lampshade.
Metallic disc and Plexiglas pendant.
Red decorative electric cable.

FINISHES

STANDARD	SPECIAL
 White	 Copper Matt
 Black	 Gold Matt
 Tan	

Article	Colour Temperature (K)	Power (W)	Nominal Flux	Measures (cm)	Weight (kg)
Eclipse Ø100	3.000 K	19W + 5W	2,600+500 lm	100x100x75	17,0

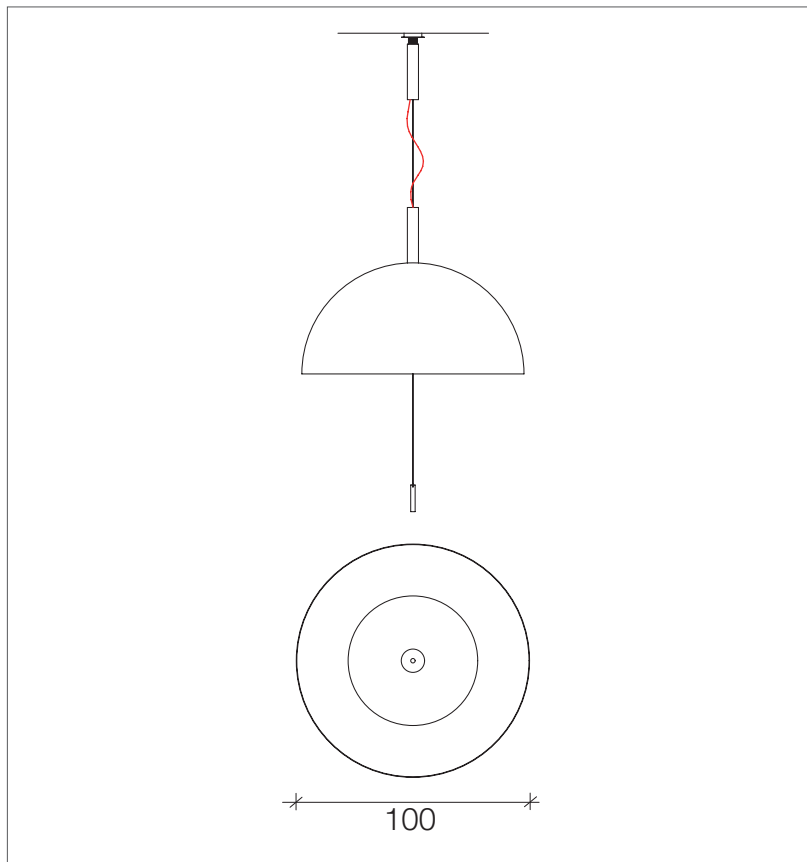

 This luminaire is compatible with bulbs of this energy classes:

This luminaire is sell with LED bulb in energy class: **A+**

A++ } **L**
A+ } **E**
A } **D**
B
C
D
E

 LIGHTDROPSDESIGN
ECLIPSE 100

874/2012

CODE CREATION

MODEL	INSIDE FINISHES	FINISHES
LDDECL100 - eclipse 100cm	1 - white	1 - white 2 - black 3 - tan 4 - gold matt 5 - copper matt